

# Data Sheet



Article number: 12858100040840

Description: KLEE-coil 858 100 040.840  
M4 Brass

## Measures

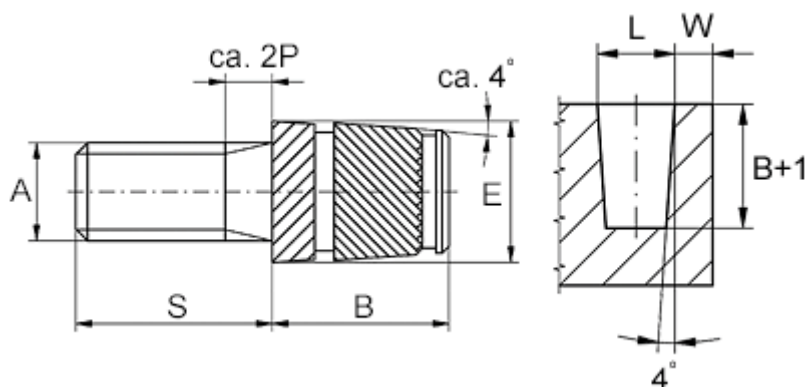

Male thread A	= M4x0,7
Min distance to edge W	= 2.0
Mounting length B	= 7.5
Outer diameter E	= 6.0
Pin length S	= 10
Recommended bore diameter W +0.1	= 5.8